

Banco

B05



GIBAM
composit

B05

Ogni progetto è unico. Attorno a questa idea è nato B05.

Un sistema componibile **altamente tecnologico**, concepito su principi di **semplicità e modularità**. Un prodotto pensato per accogliere **la più vasta gamma di accessori per il retail** presente sul mercato. Linee semplici e pulite, personalizzabili a 360° grazie ad una **esclusiva gamma di materiali**. Tutto questo è B05, perché voi ed il vostro negozio siete unici.

Every project is unique. Around this idea was born B05.

A high-tech modular system, devised on the principles of **simplicity and modularity**. A product designed to accommodate the **widest range of accessories for retail** on the market. Simple, clean lines, customizable 360 ° thanks to an **exclusive range of materials**. All this is B05, because you and your business are unique.

Il prodotto

Come è stato progettato [p.07](#) Come lo vede il cliente [p.09](#) Come lo vede l'operatore [p.11](#) Come comporre B05: la struttura [p.13](#) Come personalizzare B05: gli accessori [p.15](#)

Le applicazioni

Farmacia [p.19](#) Gioielleria [p.21](#) Abbigliamento [p.23](#) Ottica [p.25](#) Reception [p.27](#) Merceria [p.29](#) Libreria [p.31](#) Tabacchi [p.33](#) Fioreria [p.35](#) Elettronica [p.37](#)

The product

The way we designed it [p.07](#) The way the client sees it [p.09](#) The way the operator sees it [p.11](#) How to compose B05: the structure [p.13](#) How to "dress up" B05: the accessories [p.15](#)

The applications

Pharmacy [p.19](#) Jewellery [p.21](#) Fashion [p.23](#) Optical shop [p.25](#) Reception [p.27](#) Haberdashery [p.29](#) Bookstore [p.31](#) Tobacconist [p.33](#) Flower shop [p.35](#) Electronics [p.37](#)

Come è stato progettato. The way we designed it.

Robustezza Strength

Servizio clienti e zona cassa sono le aree più vissute in un punto vendita. Il banco B05 si distingue dagli standard di settore per le sue doti tecniche e l'elevata resistenza, rivoluzionando quindi il concetto di usura.

Inside a point of sale the most stressed area is that dedicated to customer service and cashier. The use of materials characterised by long durability puts B05 above the common standards, and makes a statement about the resistance to wear.

Funzionalità Functionality

B05 è stato studiato non solo come punto di appoggio o esposizione prodotti, ma come vero e proprio "centro nevralgico" all'interno del punto vendita. L'ampia gamma di accessori dedicata permette di configurare la zona retro banco secondo specifiche esigenze.

B05 has been devised not only as a place to put things down or as a showcase, but as a real center of relationship with the client. The product is furtherly completed by a large range of accessories and by the possibility to configure its back side in accordance to need.

Estetica Aesthetics

Il bello è funzionale. L'estetica minimale che caratterizza B05 si traduce in soluzioni semplici ed efficaci. L'estrema cura nella scelta dei materiali e delle superfici si traduce in un'esperienza piacevole alla vista e al tatto.

Beautiful and functional. The minimalistic aesthetics of B05 becomes simple and down-to-point solutions. Materials and surfaces chosen with great care create a pleasant visual and sensorial experience.

Convenienza Convenience

Tante idee per personalizzare B05. Una filosofia che permette di ottimizzare le risorse del retailer lasciando spazio solo a ciò che ritiene necessario. A questo si aggiunge la tecnologia LED che annulla quasi totalmente il concetto di "manutenzione" nel tempo e assicura un notevole risparmio dei consumi.

Many solutions from which to choose for the customization of B05. A philosophy that allows to optimize the resources of the retailer only taking what is necessary. To this we add the use of LED technology, that reduces to almost zero the need for maintenance over time, and becomes a money saver.



Come lo vede il cliente. The way the client sees it.

Esposizione

Vetrina ad angolo per l'esposizione di prodotti speciali.

Display solutions

Corner glass case for the display of special products.

Servizio e Assistenza

Bancalina in vetro satinato per il punto servizio/cassa.

Service and assistance

Frosted glass elevated top for the service/cashier desk.

Esposizione

Gradinale telefonica per l'esposizione "al tocco".

Display solutions

Step display for touchable mobile phones.

Esposizione

Esposizione verticale multifunzionale.

Display solutions

Vertical display.

Comunicazione

Fronte stampato con grafica personalizzata.

Communication

Printed front with thematic prints.

Servizio e Assistenza

Ripiano luminoso poggia borse.

Service and assistance

Lit shelf for bags.

Comunicazione

Box luminoso per la comunicazione.

Communication

Communication box with light.

Come lo vede l'operatore. The way the operator sees it.

Organizzazione
Cassettiera.

Organization
Chest of drawers.

Esposizione

Esposizione verticale multifunzionale.

Display solutions

Multifunctional vertical display panel.

Servizio e Assistenza

Bancalina in vetro satinato per il punto servizio/cassa.

Service and assistance

Frosted glass front top for the service/cashier area.

Esposizione

Vetrina espositiva con illuminazione.

Display solutions

Display glass case with light.

Servizio e Assistenza

Volume di assistenza e scrivania.

Service and assistance

Assistance and general desk unit.

Organizzazione
Ripiano a giorno porta stampante.

Organization
Printer shelf.

Organizzazione
Contenitore porta buste in plexiglas opale.

Organization
Bag container in milky acrylic.

Organizzazione
Contenitore grucce.

Organization
Space for hanging clothes in milky acrylic.

Organizzazione
Vano multifunzionale con ante.

Organization
Multifunctional cabinet.

Il Top

Il Top, attrezzato con o senza foro passacavo, è disponibile in una vastissima gamma di materiali.

The Top

The desk top surface, available with or without cable hole, can be produced in a very large range of materials.

La scocca

Attraverso l'unione del volume dritto e degli angoli interni ed esterni è possibile sviluppare ogni forma di layout.

The Body

The combination of the straight unit and of internal and external corners allows to develop many different shapes.

Il Frontale

Frontale e Top si abbinano perfettamente e prevedono entrambi la stampa digitale con grafica personalizzata.

The Front Panel

The Front Panel continues the top surface and can be customised also with printed materials from pictures.

Lo zoccolo

Lo Zoccolo, in plastica pvc disponibile nel colore bianco o nero, si abbina perfettamente alla struttura ed è facile da pulire.

The Skirting Board

The Skirting Board, made of PVC, available in white or black colours, perfectly matches the structures and it's easy to clean.

Il Fianco

I due Fianchi laterali terminano la composizione e si abbinano alla Scocca e allo Zoccolo.

The Side

The two sides end the product and are harmonised in finish with the body and the skirting board.

Come comporre B05: la struttura.

How to compose B05: the structure.

Tutto quello che vuoi con la massima semplicità. Abbiamo disegnato un sistema semplice e veloce da progettare, per permettervi di gestire anche le soluzioni più complesse in termini di gestione dello spazio. Un unico modulo in due altezze combinabili tra loro permettono di moltiplicare le soluzioni funzionali a disposizione del progettista. I rivestimenti, in vetro, legno e materiali compositi possono essere applicati a qualsiasi soluzione di layout.

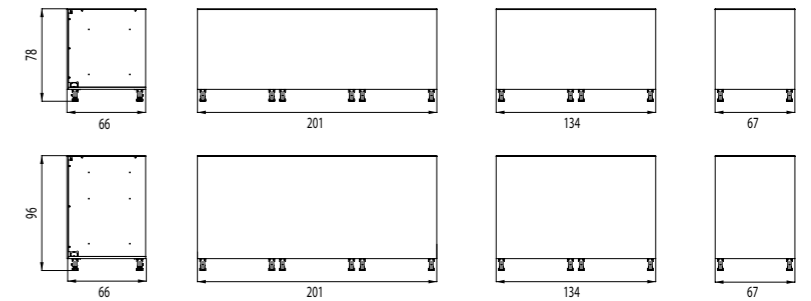

Possibili combinazioni:

Possible combinations:

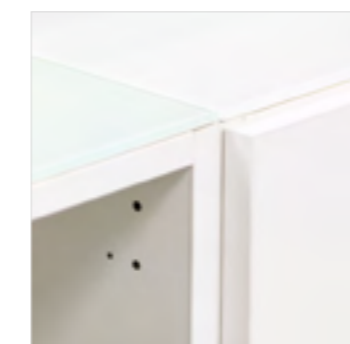
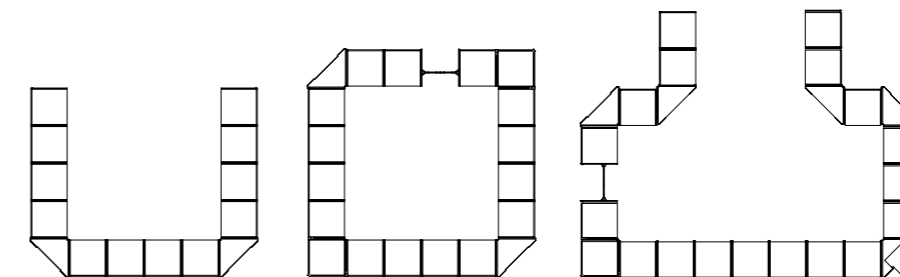
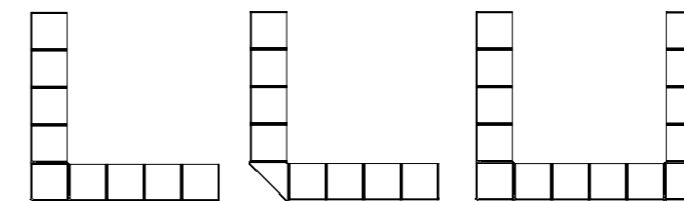
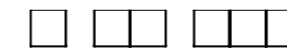

Everything you may want with the greatest simplicity. We have designed a system that is simple yet quick to be used, suitable to be applied to the most complex situations of space management. One module presented with two combinable heights that allow to create multiple functional solutions. The various surface finishing materials, as glass, wood and composites can be used in every layout solution.

Esposizione

Vetrine, gradinali al "tocco", ripiani, ecc. presentano il prodotto al meglio, trasformando il banco in un valido sistema espositivo.

Display solutions

Glass cases, step display elements for touchable products, shelves give visibility to the products and transform the counter in a valid display system.



Servizio

Gli accessori che completano le aree dedicate alla vendita assistita sono pensati per garantire il massimo comfort all'operatore e al cliente.

Service

The accessories that complete the areas dedicated to assisted sale are devised to guarantee maximum comfort to both operator and client.

Organizzazione

Cassetiera, ripiano porta tastiera, vano porta buste, sono solo alcuni degli accessori pensati per agevolare al meglio l'operatore nell'organizzazione del proprio spazio lavoro.

Organization

Chest of drawers, keyboard support, bags container, are just some of the accessories created for the operator and aimed at organise the working space.



Come personalizzare B05: gli accessori.

How to "dress" B05: the accessories.

B05 è il luogo in cui si incontrano gli aspetti legati alla gestione del punto vendita e quelli più vicini al rapporto con il cliente. Un' efficace strumento di lavoro. Una eccezionale gamma di accessori, pensati attorno a chi lavora ed alle sue esigenze specifiche, permette di attrezzare un banco altamente funzionale e professionale. La qualità dei materiali e delle finiture, la chiarezza espositiva e di servizio garantiti da B05, contribuiscono nel rinforzare la vostra immagine di retailer agli occhi dei clienti.

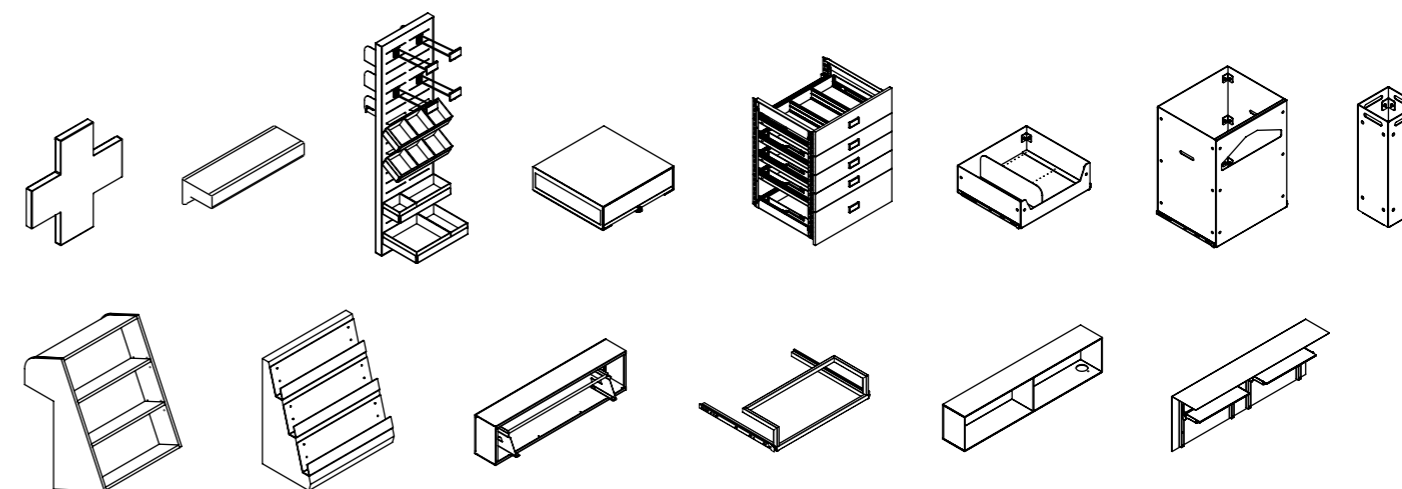
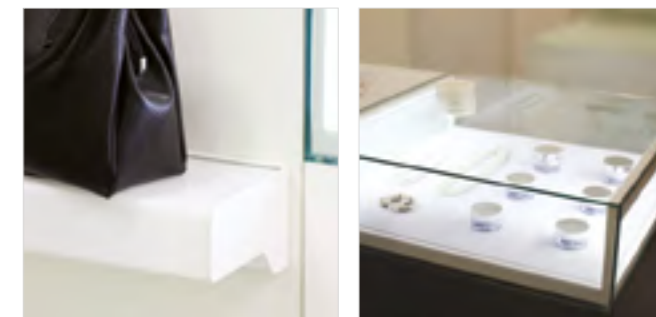

B05 is the place where the aspects related to the management of the store and the ones closest to the customer relationship meet. An effective working tool. An exceptional range of accessories designed around the people who work and its needs, allows you to equip a counter highly functional and professional. The quality of materials and finishes, the clarity of the displays and of the service guaranteed service by B05, help in reinforcing your image as a retailer in the eyes of clients.

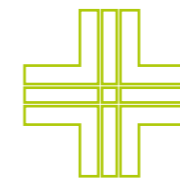

Farmacia
Pharmacy

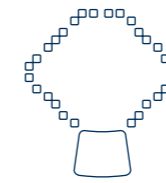

Gioielleria
Jewellery



Abbigliamento
Fashion



Ottica
Optical shops



Reception
Reception



Merceria
Haberdashery



Libreria
Bookstore

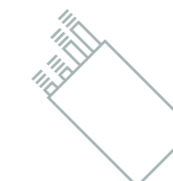

Tabacchi
Tobacconist



Fioreria
Flower shop

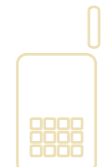

Elettronica
Electronics

Total white e legno per la farmacia.

Full white and wood for the pharmacy.



1. Insegna farmacia luminosa.
2. Cassettiera generica.
3. Cassettiera farmacia.
4. Espositore verticale - Lato cliente.
5. Espositore verticale - Lato operatore.
6. Vetrina bassa.
7. Poggiaborse.

1. Pharmacy lit sign.
2. Chest of drawer.
3. Pharmacy chest of drawers.
4. Vertical display panel - Client side.
5. Vertical display panel - Operator side.
6. Low glass case.
7. Bags holder.

 "Studiati per"
 "Devised for"



Insegna farmacia luminosa
Pharmacy lit sign



Poggiaborse
Bags holder



Espositore verticale
Vertical display panel



Vetrina bassa
Low glass case



Cassettiera farmacia
Pharmacy chest of drawers

*Attenzione: l'elenco sopra è puramente indicativo, gli accessori possono essere utilizzati per più categorie merceologiche.
*Warning: The above list is only indicative, the accessories can be used for more than one category.

Deluxe futurista per l'esposizione gioielli.

Futuristic touch for jewels display.

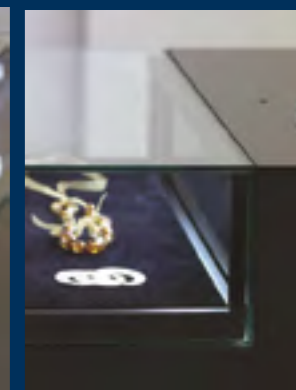
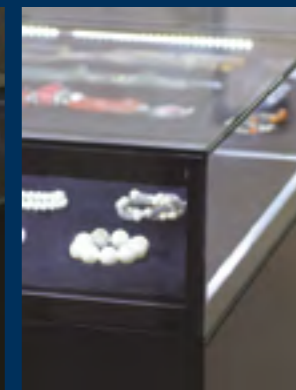
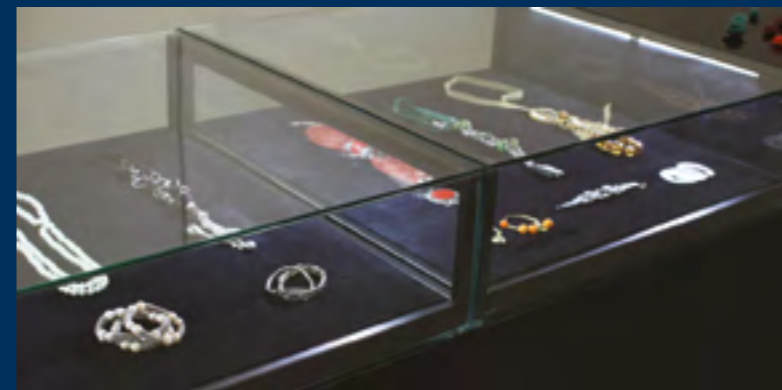

1.2.3. Vetrina bassa.
4. Cassetto cassa.
5. Contenitore buste.

1.2.3. Low glass case.
4. Cash drawer.
5. Bags holder box.



"Studiati per"
"Devised for"



Vetrina alta
High glass case



Vetrina bassa
Low glass case

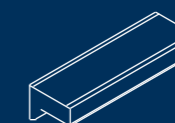

Poggiaborse
Bags holder



Cassetto cassa
Cash drawer

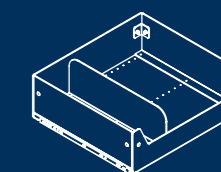

Contenitore buste
Bags holder box

*Attenzione: l'elenco sopra è puramente indicativo, gli accessori possono essere utilizzati per più categorie merceologiche.
*Warning: The above list is only indicative, the accessories can be used for more than one category.

Denim Style con top retro stampato per l'abbigliamento.

Denim Style and back-printed top for the fashion shop.

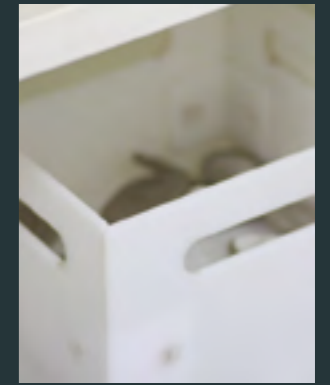

1. Cassetto cassa.
2. Tiretto tastiera pc.
3. Contenitore buste.
4. Gancera sottopiano scorrevole.
5. Contenitore grucce scorrevole.
6. Contenitore antitaccheggio/umido.

1. Cash drawer.
2. Pc keyboard sliding shelf.
3. Bags holder box.
4. Undertop sliding hook rack.
5. Sliding hangers holder.
6. Box for anti-theft tags/trash.



"Studiati per"
"Devised for"

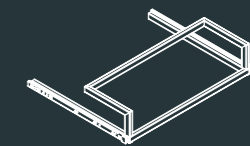

Gancera sottopiano scorrevole
Undertop sliding hook rack

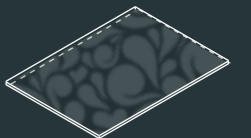

Top retro stampato
Back-printed top



Cassetto cassa
Cash drawer

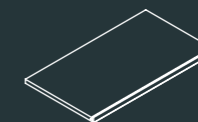

Tiretto tastiera pc
Pc keyboard sliding shelf

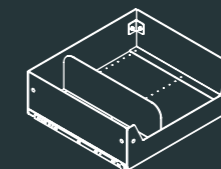

Contenitore buste
Bags holder box

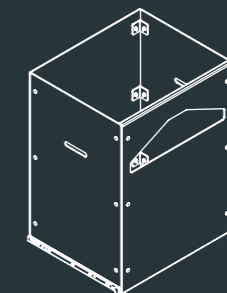

Contenitore grucce scorrevole
Sliding hangers holder



Contenitore antitaccheggio/umido
Sliding hangers holder

*Attenzione: l'elenco sopra è puramente indicativo, gli accessori possono essere utilizzati per più categorie merceologiche.
*Warning: The above list is only indicative, the accessories can be used for more than one category.

Industrial trends per l'arredo ottica.

Industrial trends for optical shops.



1.2.3. Vetrina bassa e gradinale porta occhiali.
4. Volume angolare top, frontale e fianco.
5. Bancalina frontale chiusa.

1.2.3. Low glass case and glasses step holder.
4. Outer corner top, front panel and side panel.
5. Glass front raised top.

 "Studiati per"
"Devised for"



Bancalina frontale chiusa
Glass front raised top

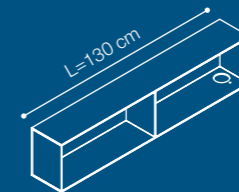

Bancalina frontale chiusa
Glass front raised top



Vetrina alta
High glass case

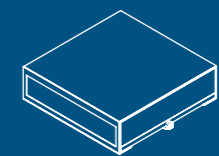

Vetrina bassa
Low glass case

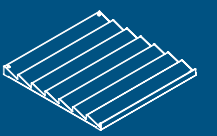

Gradinale portaocchiali
Glasses step holder

*Attenzione: l'elenco sopra è puramente indicativo, gli accessori possono essere utilizzati per più categorie merceologiche.
*Warning: The above list is only indicative, the accessories can be used for more than one category.

"Less is more" per l'area reception.

"Less is more" for the reception area.



- 1. Bancalina frontale.
 - 2. Volume angolare top, frontale e fianco.
 - 3. Tiretto tastiera pc.
 - 4.5. Top volume diritto con passacavo.
 - 6. Cassetiera generica.
 - 7. Poggiaborse.
-
- 1. Front raised top.
 - 2. Outer corner top, front panel and side panel.
 - 3. Pc keyboard sliding shelf.
 - 4.5. Straight element cable hole top cover.
 - 6. Chest of drawer.
 - 7. Bags holder.

"Studiati per"
"Devised for"



Bancalina frontale
Front raised top

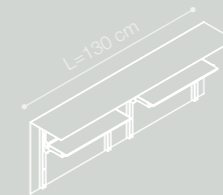

Bancalina frontale
Front raised top



Tiretto tastiera pc
Pc keyboard sliding shelf

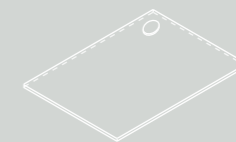

Top volume diritto con passacavo
Straight element cable hole top cover



Cassetiera generica
Chest of drawer

Ambiente caldo e accogliente per la merceria. Warm and welcoming environment for the haberdashery.



1.2.3. Vetrina bassa.
4. Zoccolo lineare.
5. Top retro stampato.

1.2.3. Low glass case.
4. Linear skirting.
5. Back-printed top.

 "Studiati per"
"Devised for"

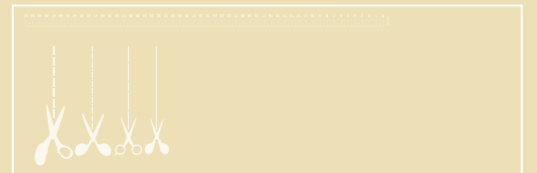

* L'utilizzo del top retro stampato permette di caratterizzare il punto vendita con grafiche "a tema". Nel caso di questa merceria, per esempio, abbiamo integrato il metro sul piano lavoro.

* The use of the back-printed top allows to give character to the point of sale with thematic prints. In this example we have integrated the meter picture on the working surface.



Vetrina alta
High glass case



Vetrina bassa
Low glass case



Cassetto cassa
Cash drawer

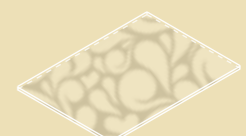

Top retro stampato*
Back-printed top*

*Attenzione: l'elenco sopra è puramente indicativo, gli accessori possono essere utilizzati per più categorie merceologiche.
*Warning: The above list is only indicative, the accessories can be used for more than one category.

Pattern decorativo per il negozio di libri.

Decorative pattern for the bookstore.



1.2.3. Espositore libri.
4. Cassettiera generica.
5.6. Portariviste.
7. Contenitore buste.
8. Cassettiera generica.

1.2.3. Books holder.
4. Chest of drawer.
5.6. Magazine holder.
7. Bags holder box.
8. Chest of drawer

"Studiati per"
"Devised for"



Cassettiera generica
Chest of drawer

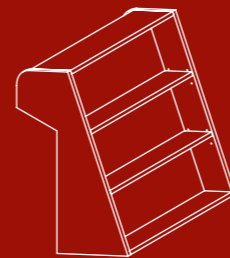

Espositore libri
Books holder

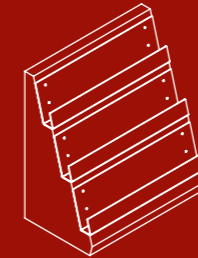

Portariviste inferiore
Lower magazine holder

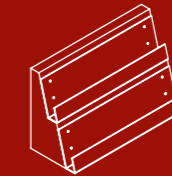

Portariviste superiore
Upper magazine holder



Cassetto cassa
Cash drawer

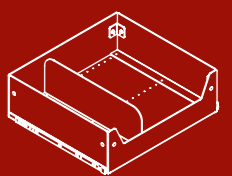

Contenitore buste
Bags holder box

*Attenzione: l'elenco sopra è puramente indicativo, gli accessori possono essere utilizzati per più categorie merceologiche.
*Warning: The above list is only indicative, the accessories can be used for more than one category.

Atmosfera classica ed elegante per il tabacchi. Classical and elegant atmosphere for the tobacconist.

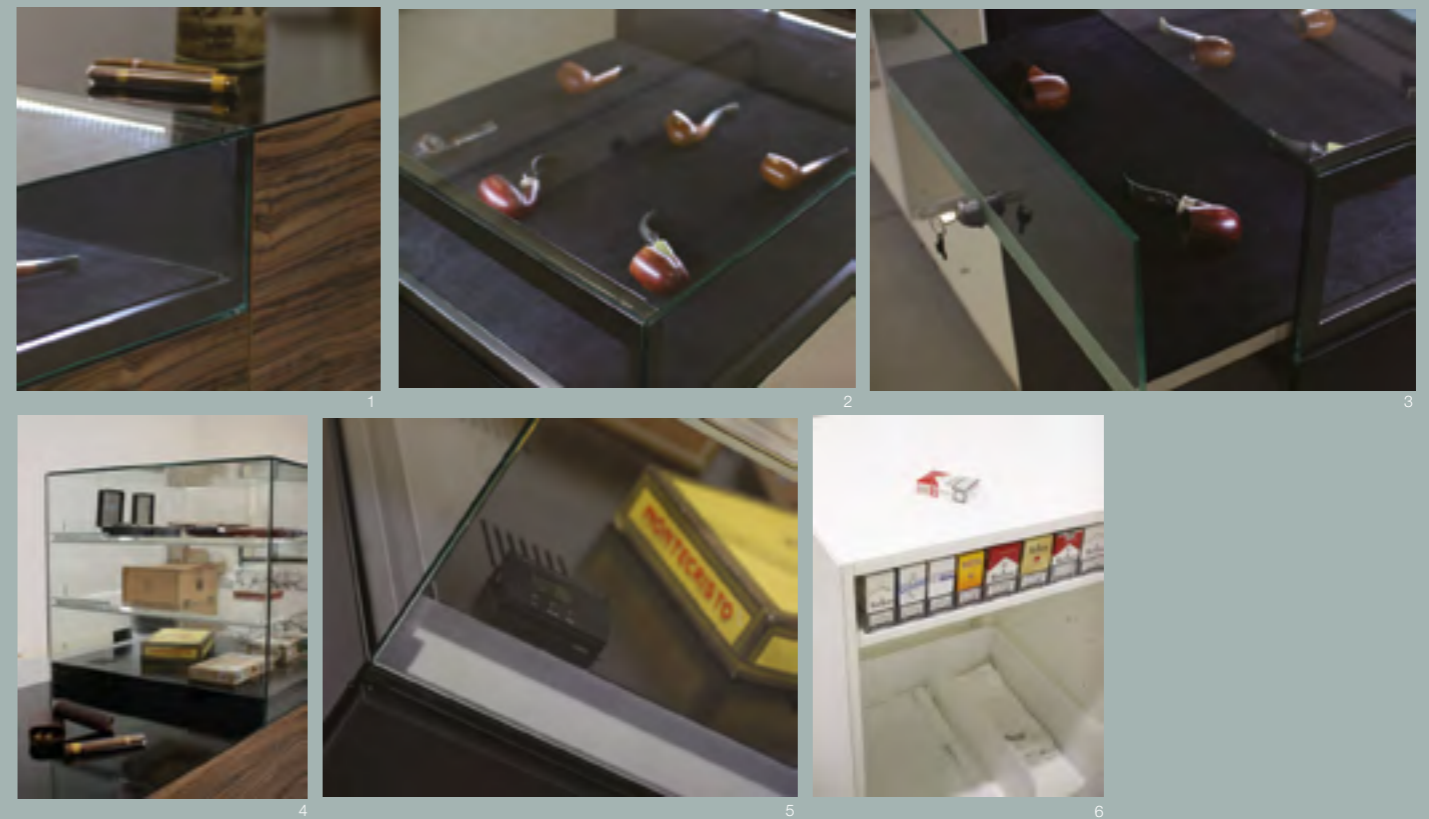

1.2.3. Vetrina bassa.
4.5. Vetrina sigari.
6. Ripiano spingi-pacchetto sigarette.

1.2.3. Low glass case.
4.5. Cigars humidor.
6. Cigarettes packet push-shelf.

"Studiati per"
"Devised for"



Ripiano
Shelf

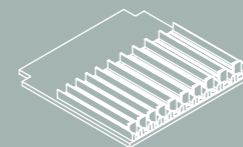

Ripiano spingi-pacchetto sigarette
Cigarettes packet push-shelf



Vetrina sigari
Cigars humidor

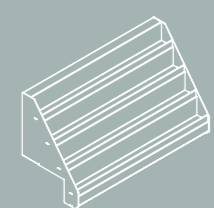

Gradinale portacaramelle
Candies holder

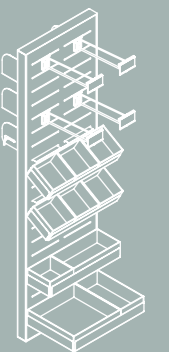

Espositore verticale
Vertical display panel

*Attenzione: l'elenco sopra è puramente indicativo, gli accessori possono essere utilizzati per più categorie merceologiche.
*Warning: The above list is only indicative, the accessories can be used for more than one category.

Massima funzionalità per il negozio di fiori.

Maximum functionality for the flower shop.



1. Portartolo per espositore.
2. Taglierina carta regalo.
3. Contenitore buste.
4. Contenitore antitaccheggio/umido.
5. Cassetto cassa.
6. Cassettiera generica.

1. Display panel roll holder.
2. Wrapping paper cutter.
3. Bags holder box.
4. Box for anti-theft tags/trash.
5. Cash drawer.
6. Chest of drawer.



"Studiati per"
"Devised for"

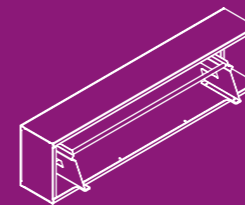

Taglierina carta regalo
Wrapping paper cutter

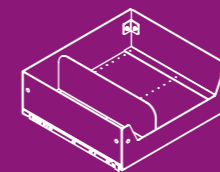

Contenitore buste
Bags holder box



Contenitore antitaccheggio/umido
Box for anti-theft tags/trash



Cassetto cassa
Cash drawer



Cassettiera generica
Chest of drawer

*Attenzione: l'elenco sopra è puramente indicativo, gli accessori possono essere utilizzati per più categorie merceologiche.
*Warning: The above list is only indicative, the accessories can be used for more than one category.

"Dark cybernetic" per il mondo elettronica.
 "Dark cybernetic" for the electronics world.

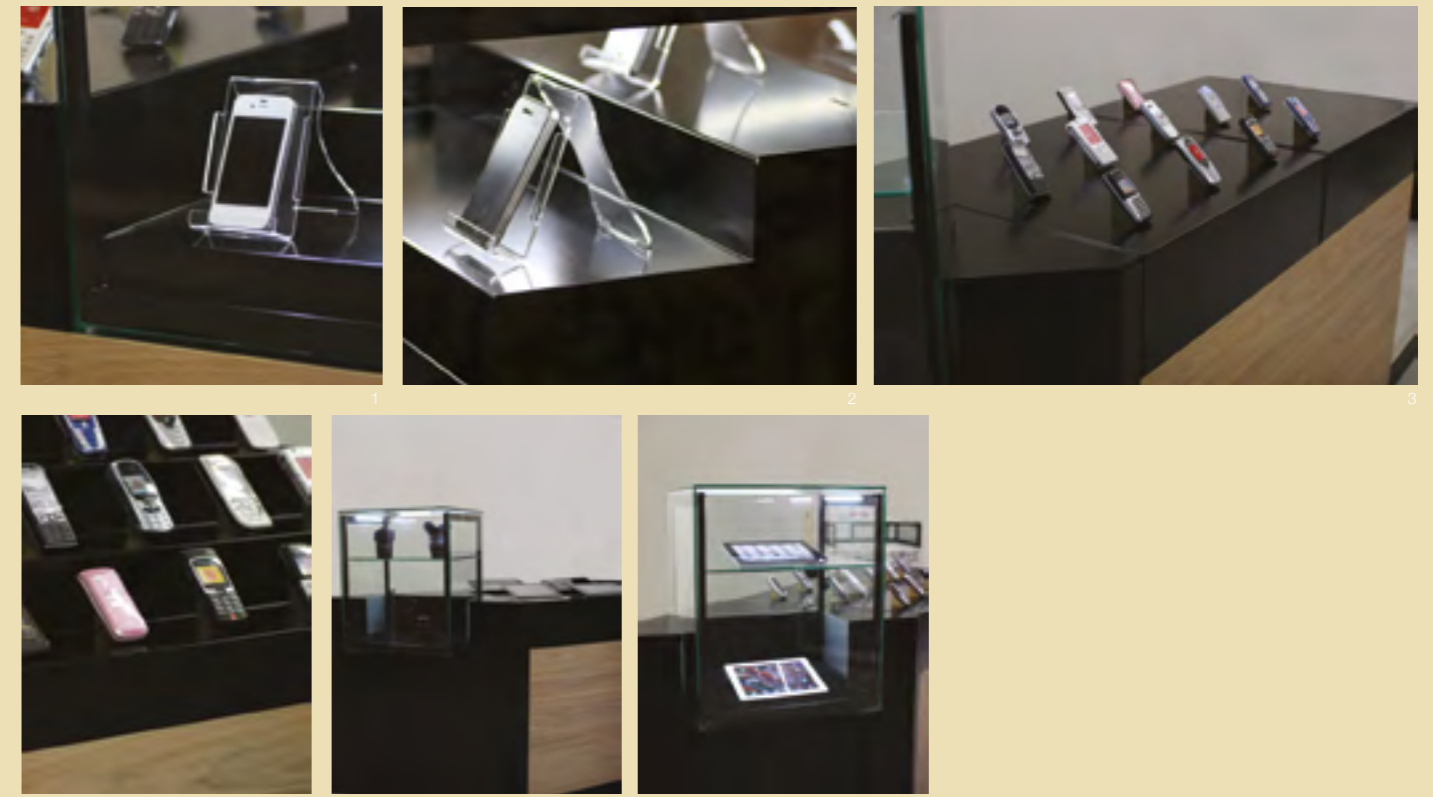

1.2. Gradinale interno.
 3. Espositore al tocco.
 4. Gradinale al tocco.

1.2. Encased step open display.
 3. Flat open display.
 4. Step open display.
 5.6. Corner high glass case.



"Studiati per"
 "Devised for"

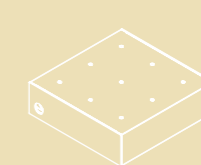

Espositore al tocco
 Flat open display



Insegna luminosa
 Blacklit signage holder



Vetrina alta
 High glass case



Vetrina bassa
 Low glass case



Vetrina angolo alta
 Corner high glass case

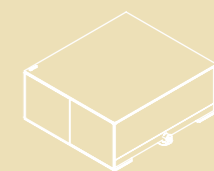

Vetrina angolo bassa
 Corner low glass case



Gradinale al tocco
 Step open display

*Attenzione: l'elenco sopra è puramente indicativo, gli accessori possono essere utilizzati per più categorie merceologiche.
 *Warning: The above list is only indicative, the accessories can be used for more than one category.

Banco

B05

B05

INDICE
INDEX







STRUTTURALI BASIC COMPONENTS

Sinottica strutturali Basis components table	42
Scocche Body	44
Frontali Front panels	46
Top Top covers	48
Zoccoli Skirtings	51
Finiture Terminali End panels	53

ACCESSORI ACCESSORIES

Sinottica accessori Accessories table	56
Servizio Service	58
Vendita Sale	61

ACCESSORI SPECIFICI SPECIFIC ACCESSORIES

 Elettronica Electronics	68
 Farmacia Pharmacy	70
 Abbigliamento Fashion	72
 Tabacchi Tobacconist	74
 Fioreria Florist	76
 Libreria/Giornali Books/Newspaper	78
 Ottica Optical	80

Banco

B05

B05 STRUTTURALI
BASIC COMPONENTS

B05 STRUTTURALI

BASIC COMPONENTS

- 1 **Volume dritto**
Straight element
- 2 **Volume angolare esterno 1**
Outer corner 1
- 3 **Volume angolare esterno 2**
Outer corner 2
- 4 **Volume angolare esterno 3**
Outer corner 3
- 5 **Volume angolare interno**
Inner corner
- 6 **Volume scrivania**
Desk element
- 7 **Frontale volume dritto**
Straight front panel
- 8 **Frontale volume angolare esterno 1**
Outer corner 1 front panel
- 9 **Frontale volume angolare esterno 2**
Outer corner 2 front panel
- 10 **Frontale volume angolare esterno 3**
Outer corner 3 front panel
- 11 **Top volume dritto**
Straight element top cover
- 12 **Top volume dritto con passacavo**
Straight element cable hole top cover
- 13 **Top volume angolare esterno 1**
Outer corner 1 top cover
- 14 **Top volume angolare esterno 2**
Outer corner 2 top cover
- 15 **Top volume angolare esterno 3**
Outer corner 3 top cover
- 16 **Top volume angolare interno**
Inner corner top cover
- 17 **Kit zoccolo lineare**
Linear skirting set
- 17.1 **Zoccolo lineare**
Linear skirting
- 18 **Giunto lineare**
Linear joint
- 18.1 **Kit zoccolo angolo interno/esterno**
Inward/outward corner skirting set
- 19 **Giunto angolare**
Corner joint
- 19.1 **Kit zoccolo angolo esterno 90°**
90° outward corner skirting set
- 20 **Finitura terminale**
End panel
- 21 **Finitura di compensazione**
Compensatory end panel
- 22 **Finitura terminale con porta basculante**
End panel with swivel door

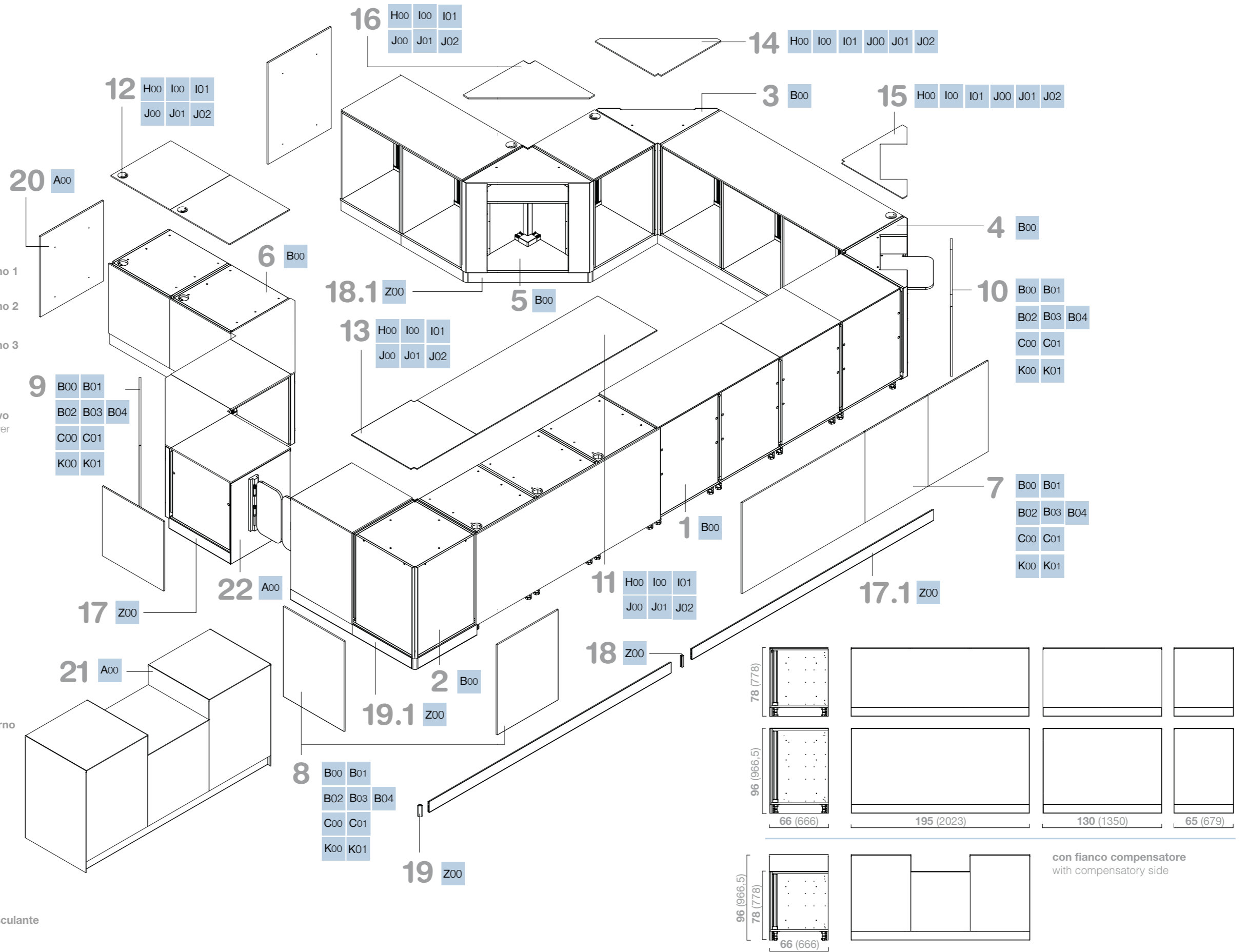

1 Volume diritto

Straight element

L	H	P	Codice Code	Tabella colori Colour chart
65	76		7083350	B00
65	96		7083000	B00

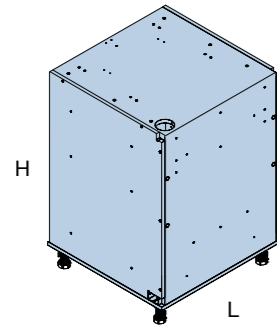

2 Volume angolare esterno 1

Outer corner 1

L	H	P	Codice Code	Tabella colori Colour chart
65	76		7083360	B00
65	96		7083010	B00

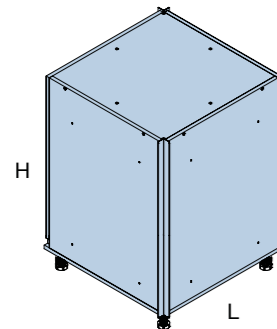

3 Volume angolare esterno 2

Outer corner 2

L	H	P	Codice Code	Tabella colori Colour chart
65	76		7083370	B00
65	96		7083020	B00

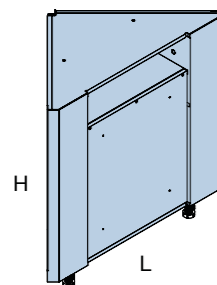

4 Volume angolare esterno 3

Outer corner 3

L	H	P	Codice Code	Tabella colori Colour chart
65	76		7083850	B00
65	96		7083750	B00

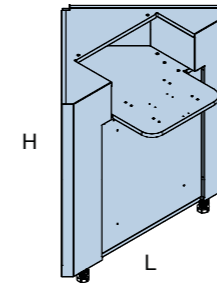

5 Volume angolare interno

Inner corner

L	H	P	Codice Code	Tabella colori Colour chart
65	76		7083380	B00
65	96		7083030	B00

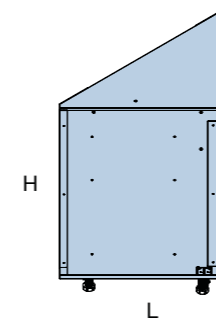

6 Volume scrivania

Desk element

L	H	P	Codice Code	Tabella colori Colour chart
65	76		7083900	B00

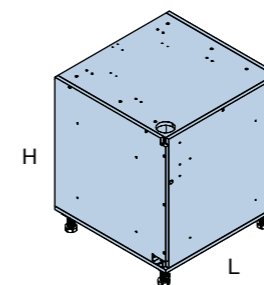

7 Frontale volume diritto

Straight front panel

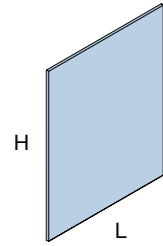

L	H	P	Codice Code	Tabella colori Colour chart
65	76		7083400	B00 B01 B02 B03 B04 C00 C01 K00 K01
130	76		7083410	B00 B01 B02 B03 B04 C00 C01 K00 K01
195	76		7083420	B00 B01 B02 B03 B04 C00 C01 K00 K01
65	96		7083230	B00 B01 B02 B03 B04 C00 C01 K00 K01
130	96		7083240	B00 B01 B02 B03 B04 C00 C01 K00 K01
195	96		7083250	B00 B01 B02 B03 B04 C00 C01 K00 K01

9 Frontale volume angolare esterno 2

Outer corner 2 front panel

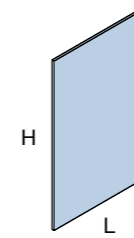

L	H	P	Codice Code	Tabella colori Colour chart
58	76		7083935	B00 B01 B02 B03 B04 C00 C01 K00 K01
58	96		7083270	B00 B01 B02 B03 B04 C00 C01 K00 K01

8 Frontale volume angolare esterno 1

Outer corner 1 front panel

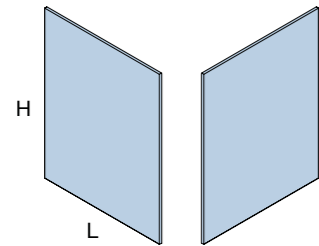

L	H	P	Codice Code	Tabella colori Colour chart
66	76		7083930	B00 B01 B02 B03 B04 C00 C01 K00 K01
66	96		7083260	B00 B01 B02 B03 B04 C00 C01 K00 K01

10 Frontale volume angolare esterno 3

Outer corner 3 front panel

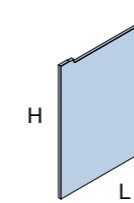

L	H	P	Codice Code	Tabella colori Colour chart
58	76		7083940	B00 B01 B02 B03 B04 C00 C01 K00 K01
58	96		7083280	B00 B01 B02 B03 B04 C00 C01 K00 K01

11 Top volume diritto
Straight element top cover

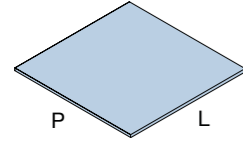

L	H	P	Codice Code	Tabella colori Colour chart
65		66	7083050	H00
65		66	7083055	I00 I01
65		66	7083067	J00 J01 J02
130		66	7083070	H00
130		66	7083075	I00 I01
130		66	7083087	J00 J01 J02
195		66	7083090	H00
195		66	7083095	I00 I01
195		66	7083107	J00 J01 J02

12 Top volume diritto con passacavo
Straight element cable hole top cover

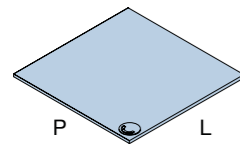

L	H	P	Codice Code	Tabella colori Colour chart
65		66	7083110	H00
65		66	7083115	I00 I01
65		66	7083127	J00 J01 J02
130		66	7083130	H00
130		66	7083135	I00 I01
130		66	7083147	J00 J01 J02
195		66	7083150	H00
195		66	7083155	I00 I01
195		66	7083167	J00 J01 J02

13 Top volume angolare esterno 1
Outer corner 1 top cover

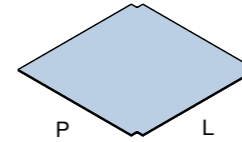

L	H	P	Codice Code	Tabella colori Colour chart
66		66	7083170	H00
66		66	7083175	I00 I01
66		66	7083187	J00 J01 J02

14 Top volume angolare esterno 2
Outer corner 2 top cover

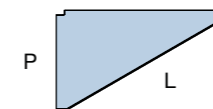

L	H	P	Codice Code	Tabella colori Colour chart
66		66	7083190	H00
66		66	7083195	I00 I01
66		66	7083207	J00 J01 J02

15 Top volume angolare esterno 3

Outer corner 3 top cover

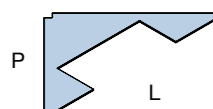

L	H	P	Codice Code	Tabella colori Colour chart
66		66	7083210	H00
66		66	7083215	I00 I01
66		66	7083227	J00 J01 J02

16 Top volume angolare interno

Inner corner top cover

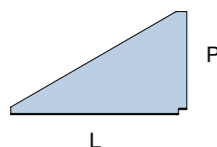

L	H	P	Codice Code	Tabella colori Colour chart
66		66	7083290	H00
66		66	7083295	I00 I01
66		66	7083310	J00 J01 J02

17 Kit zoccolo lineare

Linear skirting set

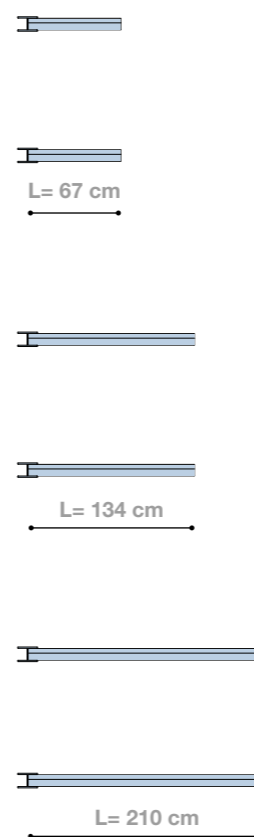

	L	H	P	Codice/code	Tabella colori Colour chart
bianco white	67	10		7086500	Z00
nero black	67	10		7086505	Z00
bianco white	134	10		7086510	Z00
nero black	134	10		7086515	Z00
bianco white	210	10		7086520	Z00
nero black	210	10		7086525	Z00

Attenzione:
il kit zoccolo comprende uno zoccolo anteriore e uno posteriore e 2 giunti lineari.

Important:
the skirting set includes the front and back skirtings and 2 linear joints.

17.1 Zoccolo lineare

Linear skirting

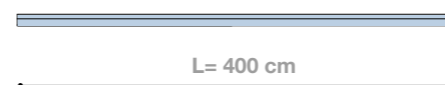

	L	H	P	Codice/code	Tabella colori Colour chart
bianco white	400	10		7083325	Z00
nero black	400	10		7083320	Z00

Attenzione:
Esclusivamente per questa lunghezza di zoccolo, i giunti eventualmente necessari non sono forniti in kit e vanno acquistati separatamente.

Important:
This length of skirting, unlike the others, is not part of a set and the linear joints must be purchased separately.

18 Giunto lineare

Linear joint



	L	H	P	Codice/code	Tabella colori Colour chart
bianco white		10		7083345	Z00
nero black		10		7083340	Z00

18.1 Kit zoccolo angolo interno/esterno

Inward/outward corner skirting set

	L	H	P	Codice/code	Tabella colori Colour chart
bianco white		10		7086540	Z00
nero black		10		7086545	Z00

Attenzione:
il kit zoccolo comprende la zoccolatura anteriore e posteriore con tutti i giunti intermedi e 2 giunti lineari.
Important:
the skirting set includes all the front and back skirtings with all intermediate joints and 2 linear joints.

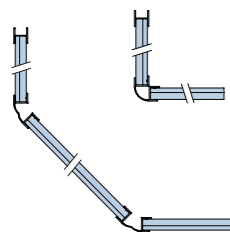

19 Giunto angolare

Corner joint

	L	H	P	Codice/code	Tabella colori Colour chart
bianco white		10		7083335	Z00
nero black		10		7083330	Z00



19.1 Kit zoccolo angolo esterno 90°

90° outward corner skirting set

	L	H	P	Codice/code	Tabella colori Colour chart
bianco white		10		7086530	Z00
nero black		10		7086535	Z00

Attenzione:
il kit zoccolo comprende la zoccolatura anteriore e posteriore con tutti i giunti intermedi e 2 giunti lineari.
Important:
the skirting set includes all the front and back skirtings with all intermediate joints and 2 linear joints.

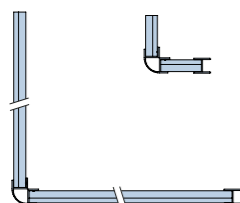

20 Finitura terminale

End panel

	L	H	P	Codice Code	Tabella colori Colour chart
dx		76	66	7083390	A00
sx		76	66	7083395	A00
dx		96	66	7083040	A00
sx		96	66	7083045	A00

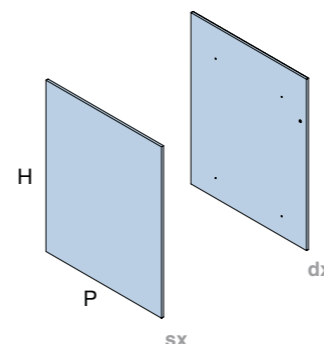

21 Finitura di compensazione

Compensatory end panel

	L	H	P	Codice Code	Tabella colori Colour chart
dx		19	66	7083975	A00
sx		19	66	7083980	A00

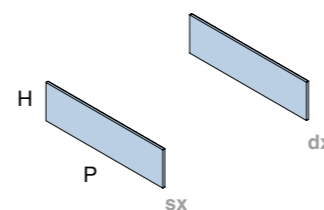

22 Finitura terminale con porta basculante

End panel with swivel door

	L	H	P	Codice Code	Tabella colori Colour chart
dx	32,5	76	66	7083950	A00
sx	32,5	76	66	7083955	A00
dx	32,5	96	66	7083915	A00
sx	32,5	96	66	7083920	A00

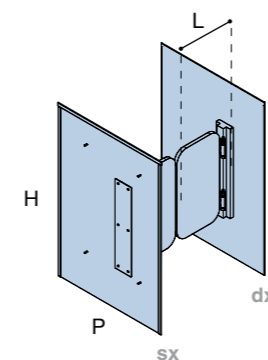

B05 ACCESSORI ACCESSORIES

B05 ACCESSORI ACCESSORIES

- 1** Cassetiera generica
Chest of drawer
- 2** Coppia ante
Doors - pair
- 3** Tiretto tastiera pc
Pc keyboard sliding shelf
- 4** Ripiano
Shelf
- 5** Cassetto cassa
Cash drawer
- 6** Contenitore buste
Bags holder box
- 7** Bancalina frontale
Front raised top
- 8** Bancalina frontale chiusa
Glass front raised top
- 9** Poggiaborse
Bags holder
- 10** Vetrina bassa
Low glass case
- 11** Vetrina alta
High glass case
- 12** Ripiano vetrine in pannello
Cloth panel for glass cases
- 13** Insegna luminosa
Backlit signage holder
- 14** Vetrina angolo bassa
Corner low glass case
- 15** Ripiano vetrine angolo in pannello
Cloth panel for corner glass cases
- 16** Vetrina angolo alta
Corner high glass case
- 17** Espositore verticale
Vertical display panel
- 18** Vaschetta portaoggetti per espositore
Display panel tray
- 19** Contenitore portaoggetti per espositore
Display panel generic tray
- 20** Ripiano portaoggetti per espositore
Display panel sided shelf
- 21** Portarotolo per espositore
Display panel roll holder
- 22** Top "mini"
"Mini" top cover

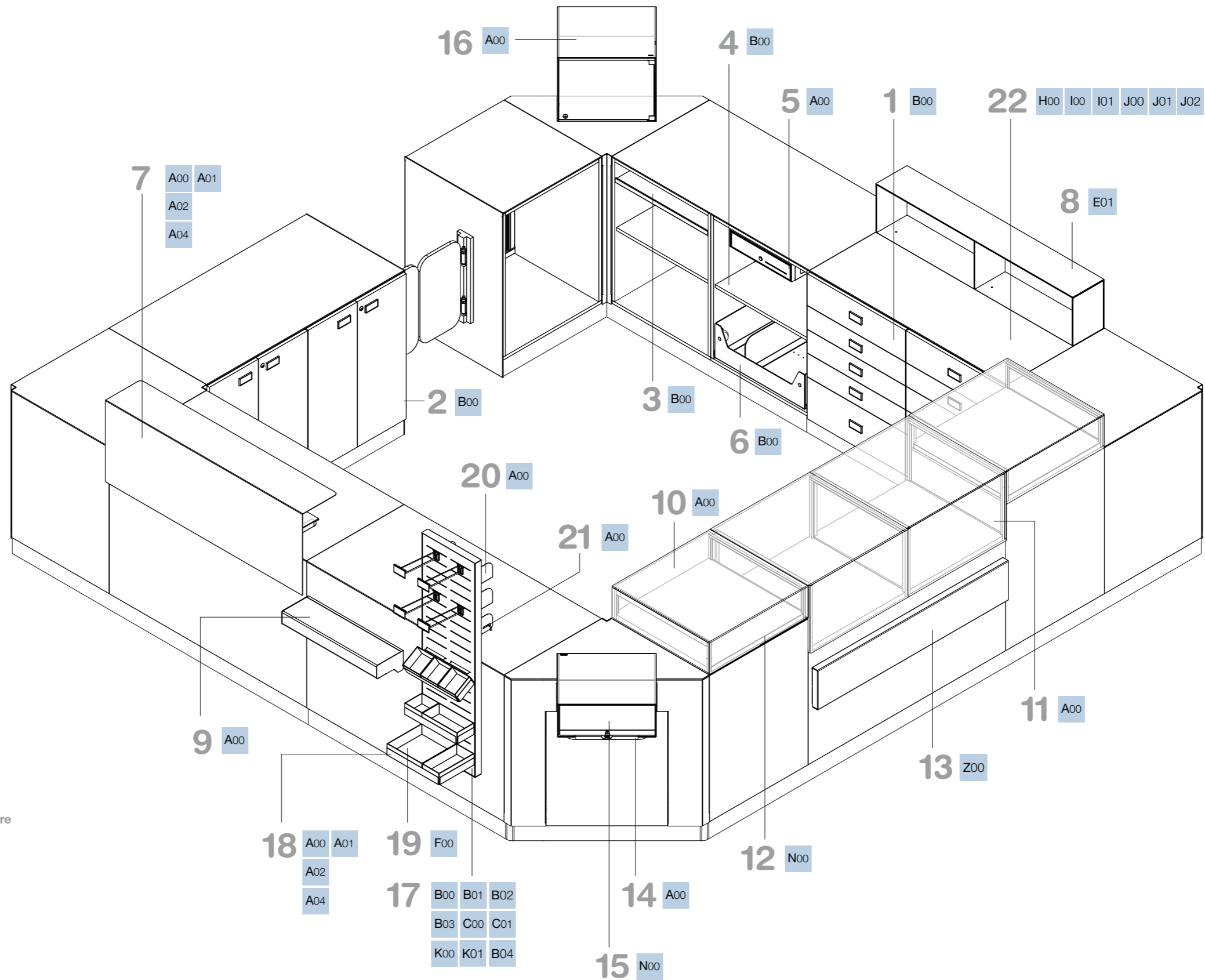

1 Cassetiera generica Chest of drawer

L	H	P	Codice Code	Tabella colori Colour chart
65	76	55	7083505	B00
65	96	55	7083500	B00

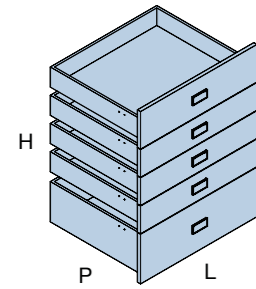

2 Coppia ante Doors - pair

L	H	P	Codice Code	Tabella colori Colour chart
65	76		7083535	B00
65	96		7083530	B00

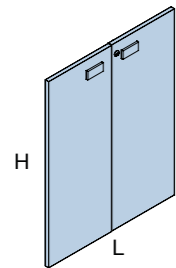

3 Tiretto tastiera pc Pc keyboard sliding shelf

L	H	P	Codice Code	Tabella colori Colour chart
65		36	7083540	B00

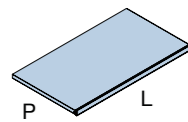

4 Ripiano Shelf

L	H	P	Codice Code	Tabella colori Colour chart
65		61	7083545	B00

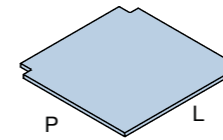

5 Cassetto cassa Cash drawer

L	H	P	Codice Code	Tabella colori Colour chart
42	11	42	7083550	A00*

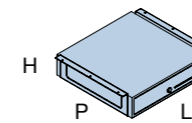

***Attenzione:
disponibile solo in nero (03T).**

***Important:
available black (03T) only.**

6 Contenitore buste Bags holder box

L	H	P	Codice Code	Tabella colori Colour chart
65	20	56	7083555	B00

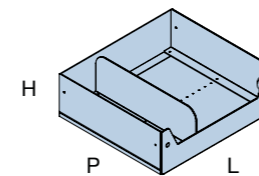

7 Bancalina frontale Front raised top

L	H	P	Codice Code	Tabella colori Colour chart
65	47	24	7083645	A00 A01 A02 A04
130	47	24	7083650	A00 A01 A02 A04

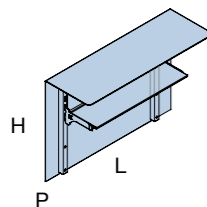

8 Bancalina frontale chiusa Glass front raised top

L	H	P	Codice Code	Tabella colori Colour chart
65	28	21	7083660	E01
130	28	21	7083665	E01

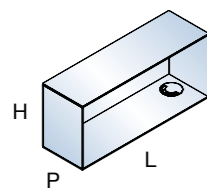

Attenzione:
solo finitura satinata.
L'uso di questo accessorio richiede il piano top "mini".

Important:
satin finish only.
This accessory requires the adoption of the "mini" top.

9 Poggiaborse Bags holder

L	H	P	Codice Code	Tabella colori Colour chart
65	11	18	7083680	A00

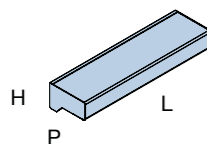

Attenzione:
Poggiaborse in acrilico con fianchi in metallo disponibili in A00.
Include 2 plafoniere a LED da 7,2 W ognuna.

Important:
Acrylic bags holder with metal sides available in A00.
Includes 2*7,2W LED lamps.

10 Vetrina bassa Low glass case

L	H	P	Codice Code	Tabella colori Colour chart
65	19	66	7083635	A00

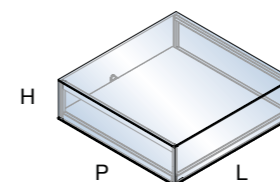

***Attenzione:**
Include 2 strips LED laterali da 11,8W complessivi

*Important:
Includes 2 LED strips absorbing 11,8W

11 Vetrina alta High glass case

L	H	P	Codice Code	Tabella colori Colour chart
65	38	66	7083640	A00

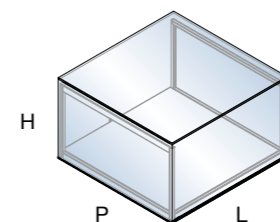

***Attenzione:**
Include 2 strips LED laterali da 11,8W complessivi.

*Important:
Includes 2 LED strips absorbing 11,8W.

12 Ripiano vetrine in pannello Cloth panel for glass cases

L	H	P	Codice Code	Tabella colori Colour chart
62		63	7083690	N00

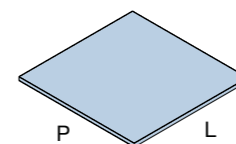

13 Insegna luminosa

Backlit signage holder

L	H	P	Codice Code	Tabella colori Colour chart
130	23	4	7083710	Z00

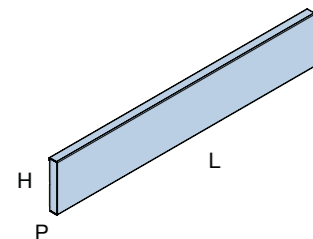

Attenzione:
insegna con struttura bianca e fronte in acrilico trasparente.
Include strip LED da 68W complessivi.

Important:
signage with white frame and transparent acrylic cover.
Includes 68W LED strip.

Dimensioni per stampa digitale
Dimensions for digital print



14 Vetrina angolo bassa

Corner low glass case

L	H	P	Codice Code	Tabella colori Colour chart
47	19	41	7083715	A00

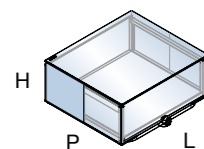

***Attenzione:**
Include 2 strips LED laterali da 11,8W complessivi.

***Important:**
Includes 2 LED strips absorbing 11,8W.

15 Ripiano vetrine angolo in panno

Cloth panel for corner glass cases

L	H	P	Codice Code	Tabella colori Colour chart
43		38	7083725	N00

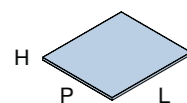

16 Vetrina angolo alta

Corner high glass case

L	H	P	Codice Code	Tabella colori Colour chart
47	57	41	7083720	A00

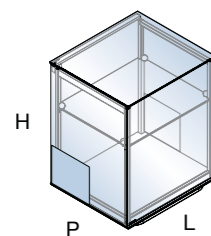

***Attenzione:**
Include 2 strips LED laterali da 11,8W complessivi.

***Important:**
Includes 2 LED strips absorbing 11,8W.

17 Espositore verticale

Vertical display panel

L	H	P	Codice Code	Tabella colori Colour chart
36	126	4	7083585	B00 B01 B02 B03 B04 C00 C01 K00 K01

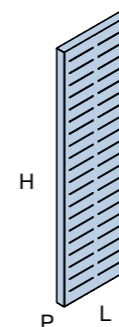

Attenzione:
l'articolo include un telaio disponibile solo in A00.

Important:
this item includes a frame available in A00 only.

18 Vaschetta portaoggetti per espositore

Display panel tray

	L	H	P	Codice Code	Tabella colori Colour chart
diritta horizontal	36	4	12	7083600	A00 A01 A02 A04
	36	4	24	7083605	A00 A01 A02 A04
inclinata oblique	36	4	12	7083610	A00 A01 A02 A04
	36	4	24	7083615	A00 A01 A02 A04

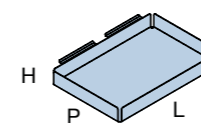

19 Contenitore portaoggetti per espositore

Display panel generic tray

L	H	P	Codice Code	Tabella colori Colour chart
12	6	12	7083620	F00
24	6	12	7083625	F00
24	6	24	7083630	F00

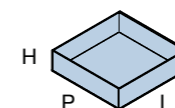

20 Ripiano portaoggetti per espositore
Display panel sided shelf

L	H	P	Codice Code	Tabella colori Colour chart
25	10	13	7083595	A00

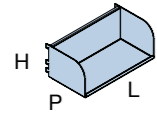

21 Portarotolo per espositore
Display panel roll holder

L	H	P	Codice Code	Tabella colori Colour chart
25	10	13	7083597	A00

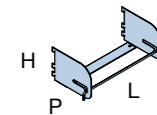

22 Top "mini"
"Mini" top cover

L	H	P	Codice Code	Tabella colori Colour chart
65		45	7083760	H00
65		45	7083765	I00 I01

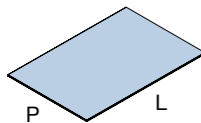

65		45	7083780	J00 J01 J02
----	--	----	---------	-------------

130		45	7083790	H00
130		45	7083795	I00 I01

130		45	7083810	J00 J01 J02
-----	--	----	---------	-------------

195		45	7083820	H00
195		45	7083825	I00 I01

195		45	7083840	J00 J01 J02
-----	--	----	---------	-------------

B05 ACCESSORI SPECIFICI SPECIFIC ACCESSORIES



- 1 **Gradinale al tocco**
Step open display
- 2 **Espositore al tocco**
Flat open display
- 3 **Gradinale interno**
Encased step open display
- 4 **Supporto telefono**
Mobiles holder

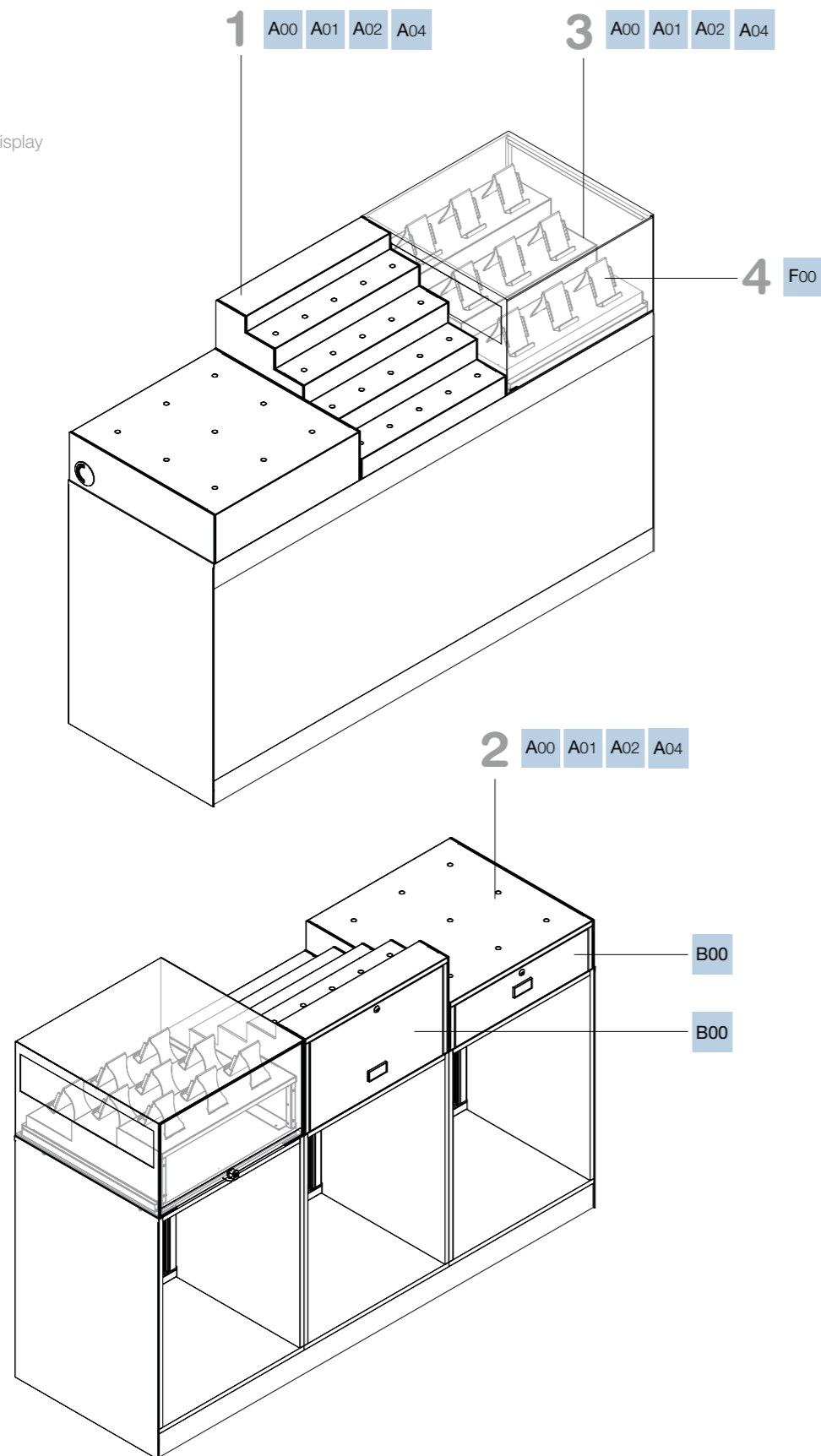

- 1 **Gradinale al tocco**
Step open display

L	H	P	Codice Code	Tabella colori Colour chart			
65	38	66	7083735	A00	A01	A02	A04

Attenzione:
Il cassetto di accesso posteriore del gradinale è disponibile in B00.

Important:
The back drawer front of the step open display is available in B00.

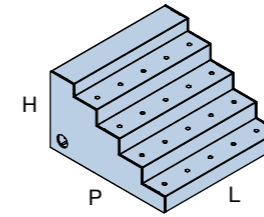

- 2 **Espositore al tocco**
Flat open display

L	H	P	Codice Code	Tabella colori Colour chart			
65	19	66	7083740	A00	A01	A02	A04

Attenzione:
Il cassetto di accesso posteriore dell'espositore è disponibile in B00.

Important:
The back drawer front of the flat open display is available in B00.

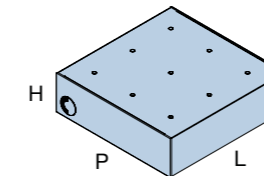

- 3 **Gradinale interno**
Encased step open display

L	H	P	Codice Code	Tabella colori Colour chart			
65		63	7083730	A00	A01	A02	A04

Attenzione:
compatibile solo con vetrina alta.

Important:
for high glass case only.

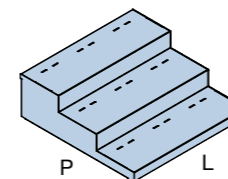

- 4 **Supporto telefono**
Mobiles holder

L	H	P	Codice Code	Tabella colori Colour chart			
8	14		7083985	F00			

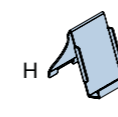

- 1 **Cassettiera farmacia**
Pharmacy chest of drawers
- 2 **Divisorio trasversale basso**
Short transversal divider
- 3 **Divisorio trasversale alto**
High transversal divider
- 4 **Divisorio longitudinale**
Lengthwise divider
- 5 **Insegna farmacia luminosa**
Pharmacy lit sign
- 6 **Gradinale portacaramelle**
Candies step holder

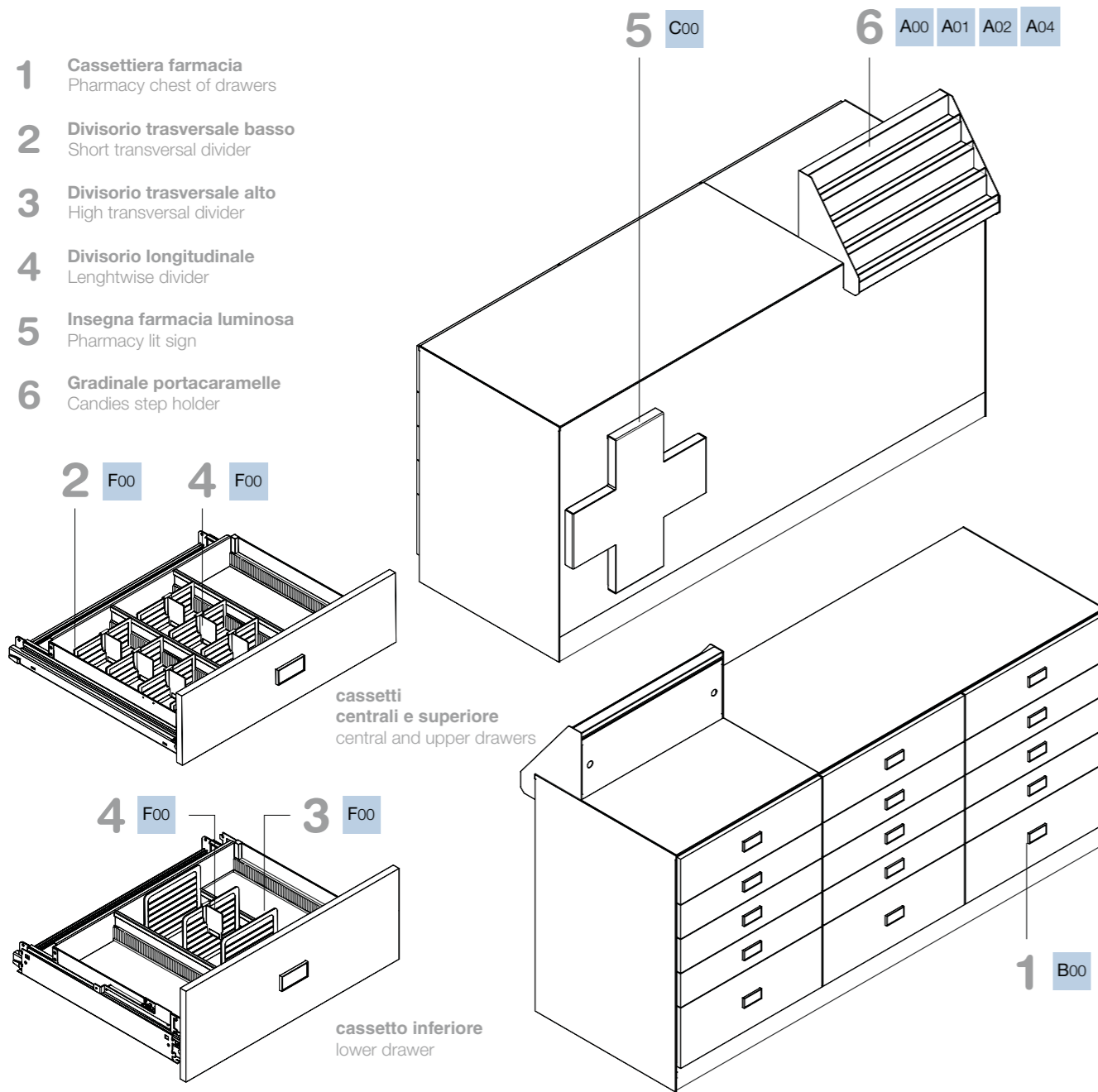

- 1 **Cassettiera farmacia**
Pharmacy chest of drawers

L	H	P	Codice Code	Tabella colori Colour chart
65	96	57	7083520	B00

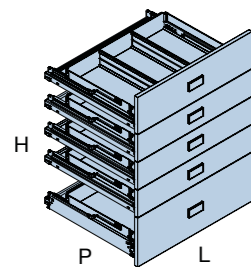

- 2 **Divisorio trasversale basso**
Short transversal divider

L	H	P	Codice Code	Tabella colori Colour chart
17	8		7083995	F00

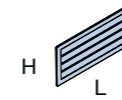

- 3 **Divisorio trasversale alto**
High transversal divider

L	H	P	Codice Code	Tabella colori Colour chart
17	15		7084000	F00

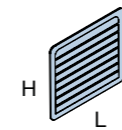

- 4 **Divisorio longitudinale**
Lengthwise divider

L	H	P	Codice Code	Tabella colori Colour chart
	7,5	5,6	7083990	F00



- 5 **Insegna farmacia luminosa**
Pharmacy lit sign

L	H	P	Codice Code	Tabella colori Colour chart
63	63	4	7083685	C00*

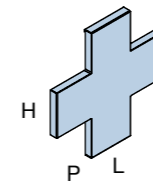

***Attenzione:**
Insegna luminosa con fronte in acrilico "Altuglas 24057" e struttura di supporto disponibile solo in bianco (06Z).
Include LED da 60W complessivi.

***Important:**
Lit sign with "Altuglas 24057" acrylic front and support structure available in white (06Z) only.
Includes 60W LED.

- 6 **Gradinale portacaramelle**
Candies step holder

L	H	P	Codice Code	Tabella colori Colour chart
65	38	29	7083925	A00 A01 A02 A04

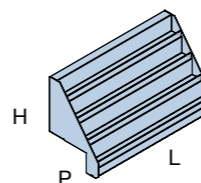

Attenzione:
l'uso di questo accessorio richiede il piano top "mini".
Important:
this accessory requires the adoption of the "mini" top.

1 Contenitore grucce scorrevole
Sliding hangers holder

2 Gancera sottopiano scorrevole
Undertop sliding hook rack

3 Contenitore antitaccheggio/umido
Box for anti-theft tags/trash

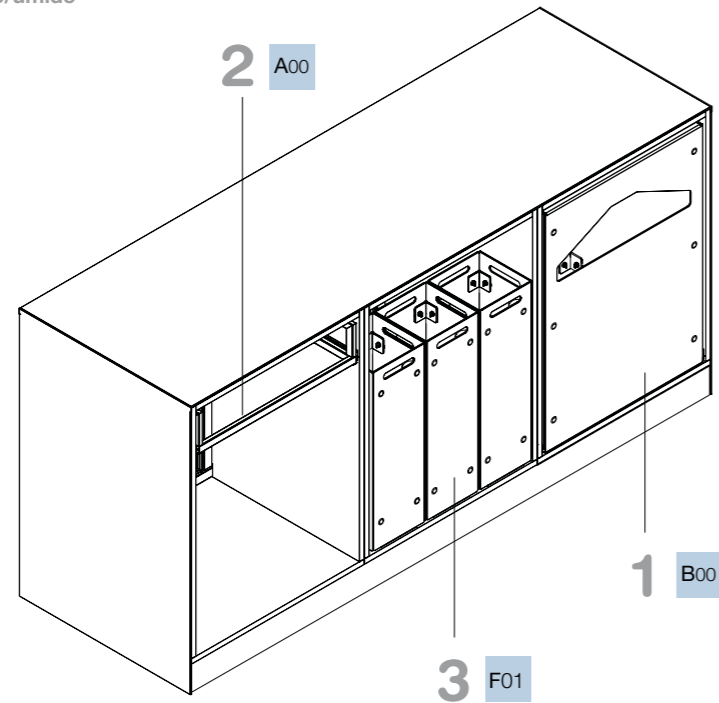

1 Contenitore grucce scorrevole
Sliding hangers holder

L	H	P	Codice Code	Tabella colori Colour chart
65	80	51	7083560	B00

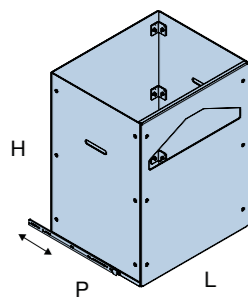

2 Gancera sottopiano scorrevole
Undertop sliding hook rack

L	H	P	Codice Code	Tabella colori Colour chart
65	13	50	7083570	A00

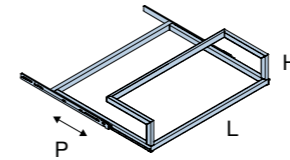

3 Contenitore antitaccheggio/umido
Box for anti-theft tags/trash

L	H	P	Codice Code	Tabella colori Colour chart
20	60	20	7083965	F01

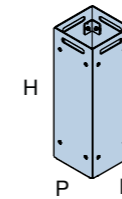



1 Vetrina sigari
Cigars humidor

2 Ripiano spingi-pacchetto sigarette
Cigarettes packet push-shelf

3 Gradinale portacaramelle
Candies holder

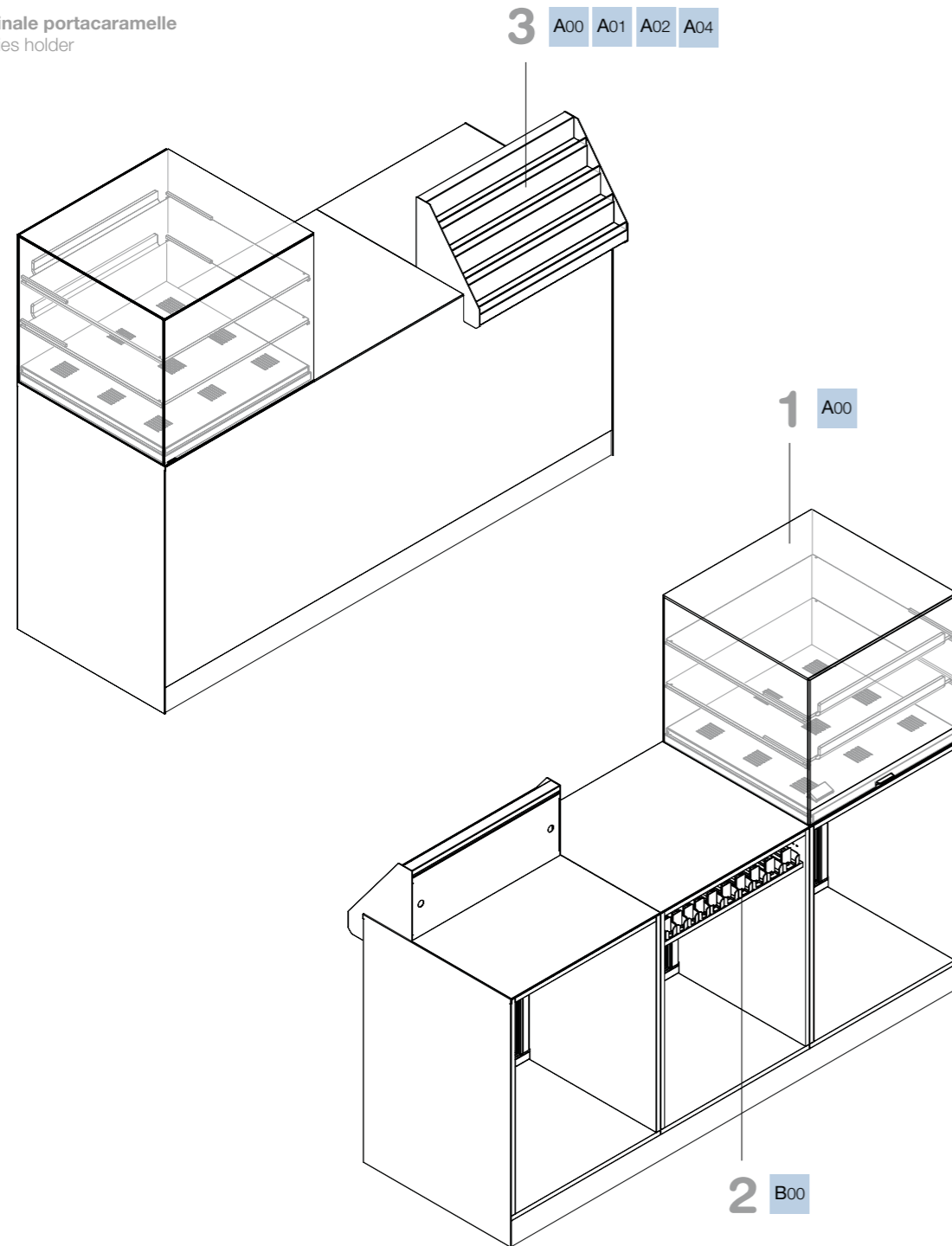

1 Vetrina sigari
Cigars humidor

L	H	P	Codice Code	Tabella colori Colour chart
65	58	66	7083910	A00

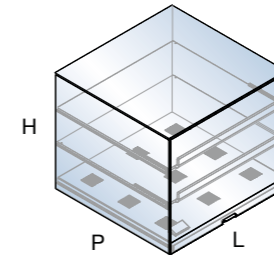

2 Ripiano spingi-pacchetto sigarette
Cigarettes packet push-shelf

L	H	P	Codice Code	Tabella colori Colour chart
65		61	7083580	B00

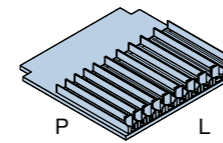

***Attenzione:**
4 divisori per pacchetti da 10 sigarette. Totale 80 pezzi.
6 divisori per pacchetti da 20 sigarette. Totale 96 pezzi.

***Important:**
4 partitions for 10-cigarette packets. Total 80 pieces.
6 partitions for 20-cigarette packets. Total 96 pieces.

3 Gradinale portacaramelle
Candies holder

L	H	P	Codice Code	Tabella colori Colour chart
65	38	29	7083925	A00 A01 A02 A04

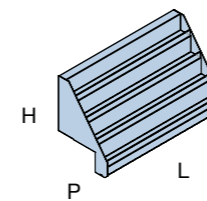

Attenzione:
l'uso di questo accessorio richiede il piano top "mini".

Important:
this accessory requires the adoption of the "mini" top.

1 Taglierina carta regalo
Wrapping paper cutter

2 Contenitore antitaccheggio/umido
Box for anti-theft tags/trash

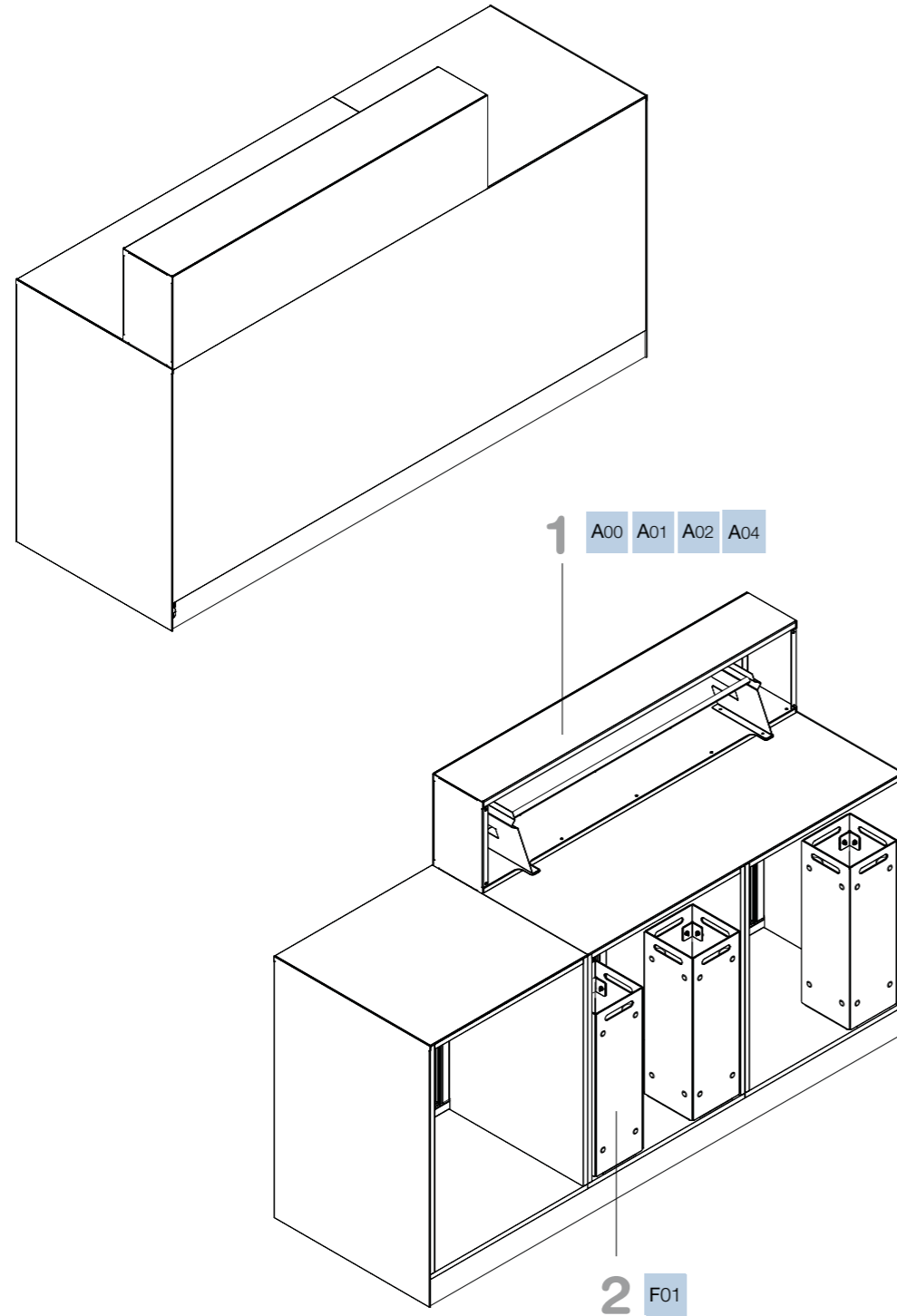

1 Taglierina carta regalo
Wrapping paper cutter

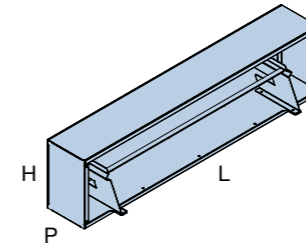

L	H	P	Codice Code	Tabella colori Colour chart			
130	34	21	7083960	A00	A01	A02	A04

Attenzione:
l'uso di questo accessorio richiede il piano top "mini".
Important:
this accessory requires the adoption of the "mini" top.

2 Contenitore antitaccheggio/umido
Box for anti-theft tags/trash

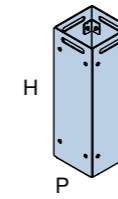

L	H	P	Codice Code	Tabella colori Colour chart			
20	60	20	7083965	F01			



- 1** Espositore libri
Books holder
- 2** Portariviste superiore
Upper magazine holder
- 3** Portariviste inferiore
Lower magazine holder
- 4** Separatore portariviste
Magazine holder divider

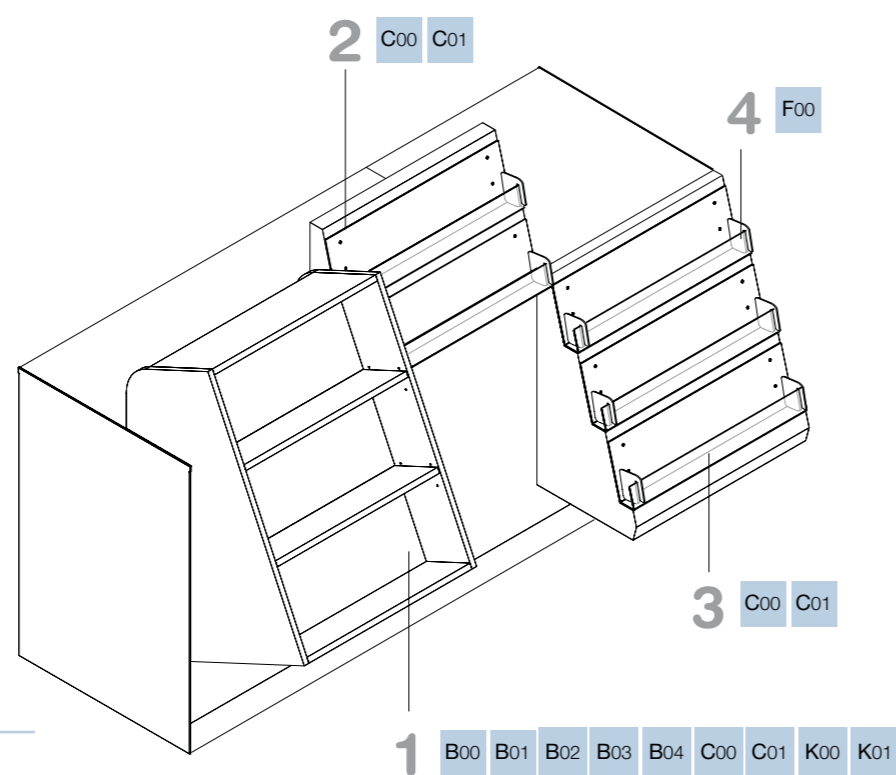

Attenzione:
i portariviste possono essere montati
singolarmente, sovrapposti o affiancati.

Important:
the magazine holders can be used singularly,
one over the other or side by side.

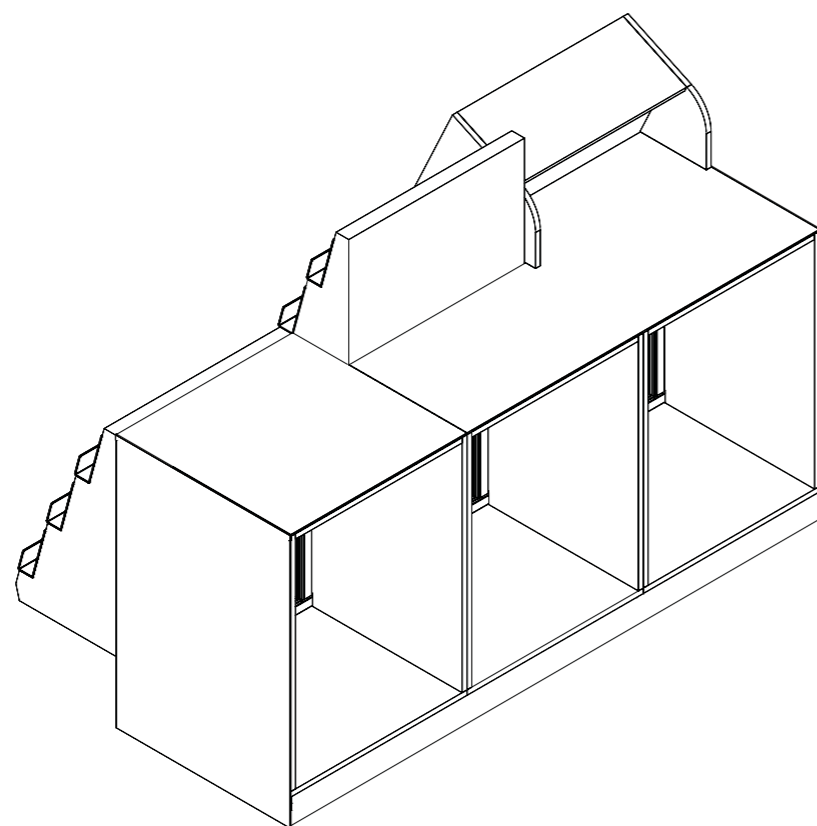
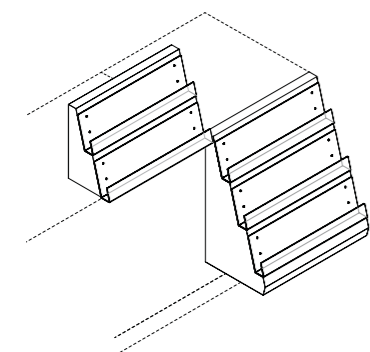
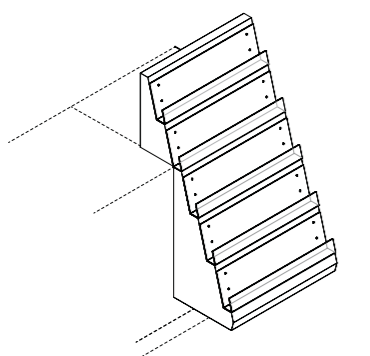

- 1** Espositore libri
Books holder

L	H	P	Codice Code	Tabella colori Colour chart
65	100	44	7083670	B00 B01 B02 B03 B04 C00 C01 K00 K01

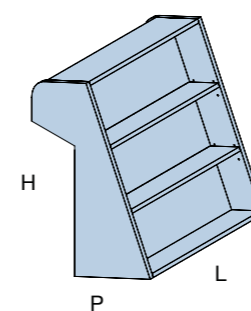

- 2** Portariviste superiore
Upper magazine holder

L	H	P	Codice Code	Tabella colori Colour chart
65	42	27	7083675	C00 C01

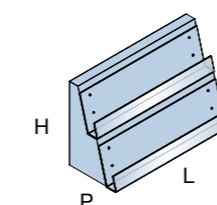

Attenzione:
l'uso di questo accessorio richiede il piano top "mini".

Important:
this accessory requires the adoption of the "mini" top.

- 3** Portariviste inferiore
Lower magazine holder

L	H	P	Codice Code	Tabella colori Colour chart
65	73	39	7083860	C00 C01

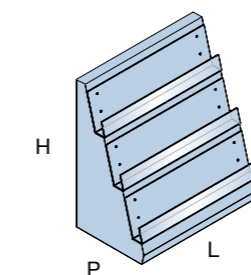

- 4** Separatore portariviste
Magazine holder divider

L	H	P	Codice Code	Tabella colori Colour chart
1	10	8	7083865	F00



Attenzione:
solo acrilico trasparente.

Important:
transparent acrylic only.

1 Gradinale portaocchiali
Glasses step holder

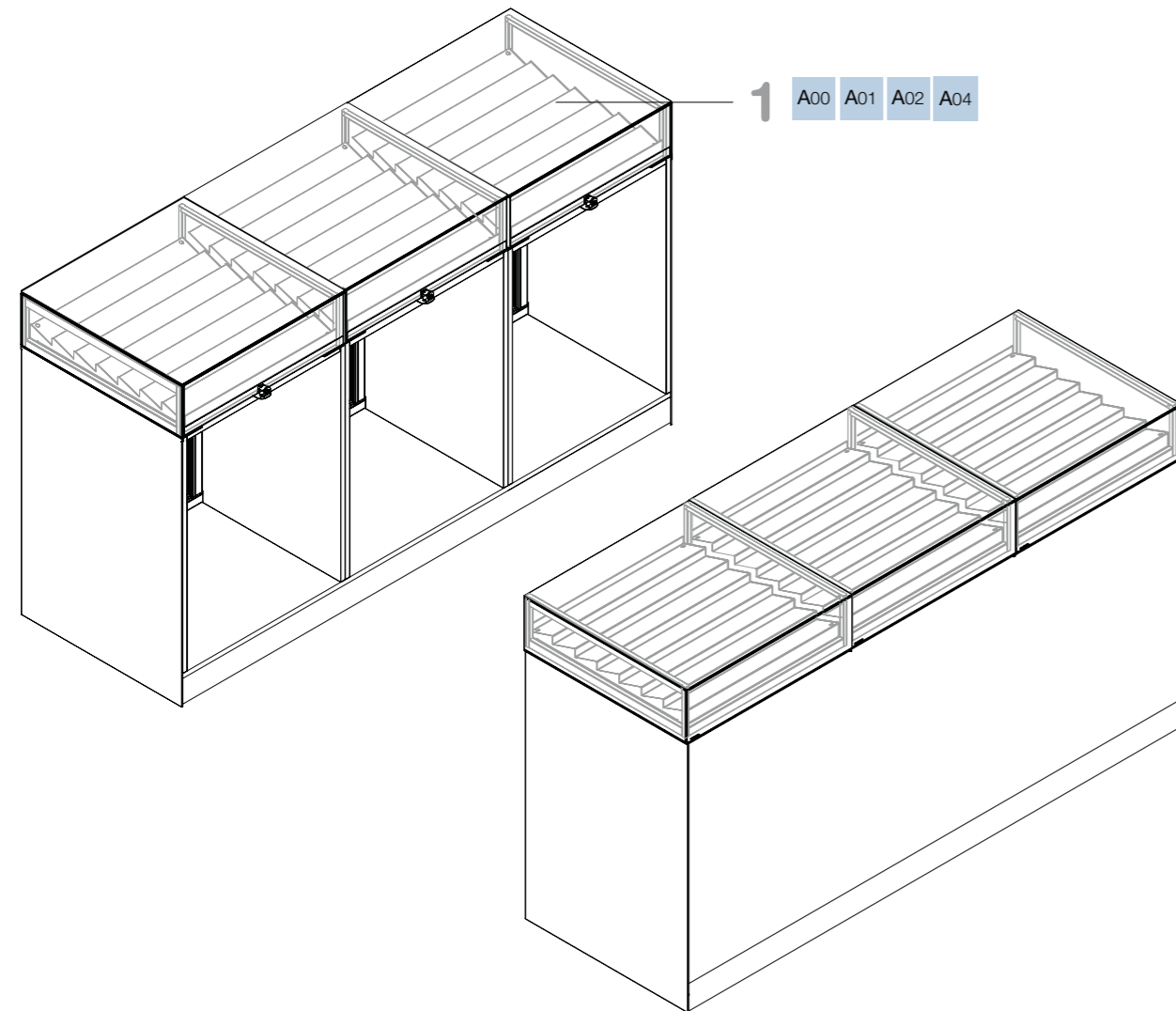

1 Gradinale portaocchiali
Glasses step holder

L	H	P	Codice Code	Tabella colori Colour chart			
62	5	63	7083945	A00	A01	A02	A04

Attenzione:
l'uso di questo accessorio richiede la vetrina bassa.
Important:
this accessory requires the adoption of the low glass case.

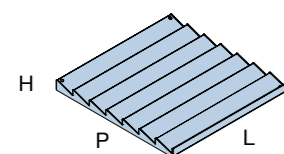

Banco

B05

stampato in Italia
printed in Italy

© GIBAM SHOPS spa - unipersonale

Settembre 2021
September 2021

direzione artistica Anidride Design
art direction Anidride Design

design di Nicola De Pellegrini - Anidride Design
design by Nicola De Pellegrini - Anidride Design

render Alessandro Pregolato
render Alessandro Pregolato

è vietata la riproduzione totale o parziale del catalogo
senza previa autorizzazione di Gibam Shops spa - unipersonale.
this catalogue cannot be partially or totally reproduced unless
Gibam Shops spa - unipersonale has granted permission to do so.



GIBAM composit

100%
MADE IN ITALY

GIBAM SHOPS spa - unipersonale

Via VIII Strada, 13
61032 Bellocchi di Fano (PU)
ITALIA
tel.: +39 0721 85991

www.gibamcomposit.com
marketing@gibamcomposit.com

X0NCFB05